

40' Flat Rack Containers

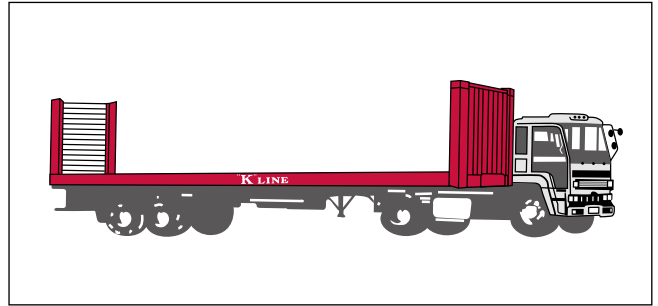
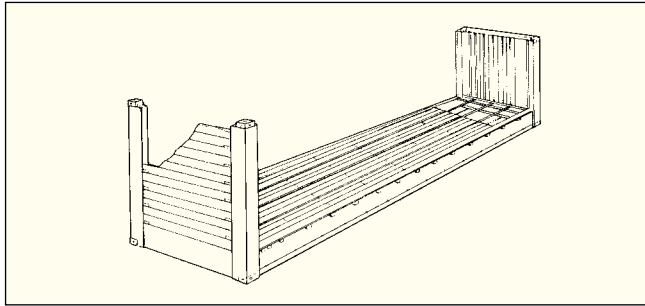

Height	Material	Tare Weight (kg/lbs)	Max* Cargo Cap. (kg/lbs)	Door Opening		Interior Dimensions			Interior Cube (m³/cft)
				Width (mm/ft)	Height (mm/ft)	Length (mm/ft)	Width (mm/ft)	Height (mm/ft)	
8'– 6"	Steel	5,100 11,243	44,900 98,985	—	—	12,072 39' 11"	2,374 7' 9.5"	1,959 6' 5"	—

Remarks * : Subject to road and rail weight limitations.
 : Above are typical figures for this type of containers.